



# FORESTRY TYRE TRACKS

GET MORE GRIP & PULL MORE WOOD WITH A SET OF VERIGA FORESTRY TYRE TRACKS ON YOUR SKIDDERS & FOWARDERS!

Call **0800 654 323** to order your Tyre Tracks **now!**



**West-Trak**<sup>®</sup>  
UNRIVALLED STRENGTH



**VERIGA** forest



# FORESTRY TYRE TRACKS

---

**Get a grip & pull more wood with  
Veriga Tyre Tracks on your forestry  
Fowarders & Skidders.**

*“Increase traction, maximise productivity”*

---

■ THE BENEFITS OF TYRE TRACKS .....	5
■ SINGLE WHEEL TYRE TRACKS .....	7
■ BOGIE WHEEL TYRE TRACKS .....	9
■ CONNECTING LINKS & TENSIONERS .....	10
■ TYRE TRACK PACKAGING .....	11
■ TYRE TRACK FITTING INSTRUCTIONS .....	12
■ MACHINE CLEARANCE & TRACK TENSION .....	14
■ TYRE SUITABILITY & PRESSURES .....	15
■ DRIVING WITH TYRE TRACKS .....	16
■ TYRE TRACK MAINTENANCE .....	17

---



**VERIGA** forest

# THE BENEFITS OF TYRE TRACKS

Veriga Forestry Tyre Tracks are manufactured from special boron alloy steel. The durability and toughness of the steel is maximized using a oil quenched heat treatment process.

Specifically designed and manufactured steel sections and forgings are used to give high performance combined with the longest possible working life. Each set of tracks has been manufactured for use with a particular tyre and should only be used as recommended by this handbook.

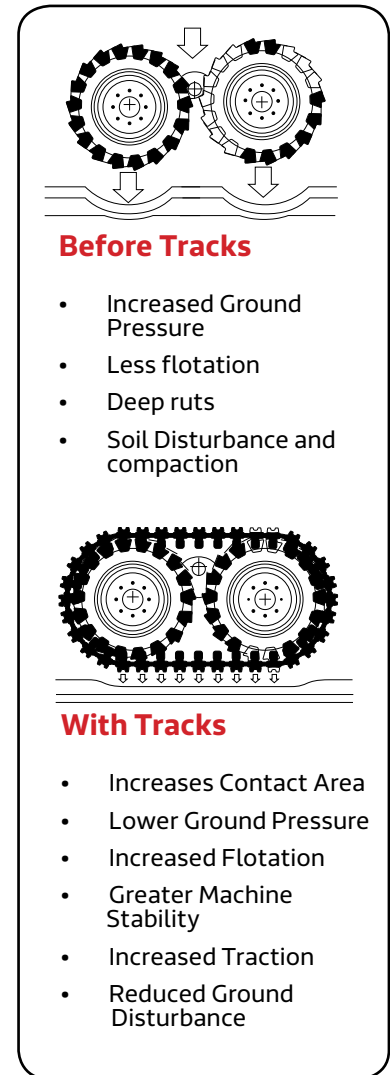

## Increased Machine Stability

Tyre Tracks offer significant stability to your machine by increasing the traction footprint and lowering the machines center of gravity. This is particularly advantageous on steep slopes with loader crane movements.

## Reduced Fuel Consumption

Tyre Tracks reduce the drag that the tyres add to the machines transmission & prevents wheel spinning, therefore reducing fuel usage.

## Reduced Ground Damage

Tyre Tracks provide greater flotation which minimizes ground disturbance, reduces ground pressure on sensitive soils & ensures constant levels of grip and traction.

## Increased Traction & Safety

Tyre Tracks significantly increase traction compared to normal tyres. This allows forestry machines to climb slopes safely and negotiate obstacles that would otherwise have been too dangerous or impossible.

## Tyre Protection

Tyre Tracks are compatible with a wide range of forestry tyres offering protection from punctures & other damage and in many cases increasing the overall lifetime of the tyres.



**VERIGA** forest

# SINGLE WHEEL TYRE TRACKS

## Green TRACK MULTI

Get a grip & pull more wood with a set of Veriga Tyre Tracks on your Skidders! These tracks will improve the productivity & performance of your machines in the most extreme working conditions.

This track design has 2 lugs on each cleat providing the ultimate grip in steep, rocky, muddy & snowy conditions. All components of these tracks are made from heat treated steel for maximum strength & service life.



## BENEFITS OF TYRE TRACKS

- Increased traction & pulling power
- Protection for your tyres
- Less wheel spinning & fuel burn
- Safer on the slopes
- Better steering ability
- Less ground disturbance
- More machine stability
- Extra log load capacity

Tyre Size	Part No
30.5 x 32	VE.WMUS30-30.5-32
35.5 x 32	VE.WMUS30-35.5-32

Your set of Tyre Tracks come complete with 2x assembly hooks, 8x 75mm short joining links and 8x 120mm medium joining links.

Track tensioners longer joining links are supplied separately if required.





**VERIGA** forest



# BOGIE WHEEL TYRE TRACKS

## Green TRACK GROOVE

Go more places & get more done with a set of Veriga Tyre Tracks on your Skidders & Forwarders! These tracks will improve the productivity & performance of your machine in the most extreme working conditions.

This track design has 1 lug on each cleat alternating sides which provides the best grip in steep, rocky, muddy & snowy conditions. All components of these tracks are made from heat treated steel for maximum strength & wear resistance.



## BENEFITS OF TYRE TRACKS

- **Increased traction & pulling power**
- **Protection for your tyres**
- **Less wheel spinning & fuel burn**
- **Safer on the slopes**
- **Better steering ability**
- **Less ground disturbance**
- **More machine stability**
- **Extra log load capacity**

Tyre Size	Part No
750/55-26.5 FKF2	VE.GR26.750-26.5.FR24
780/50-28.5 FKF2	VE.GR26.780-28.5.FR

Your set of Tyre Tracks come complete with 2x assembly hooks, 8x 75mm short joining links and 8x 120mm medium joining links.

Track tensioners, longer joining links & extension kits are supplied separately if required.



# CONNECTING LINKS & TENSIONERS

- The link design is an asymmetric shape with 30mm longitudinal length for long wear life
- All links are made from quality boron steel & heat treated by a special oil quenching process for better through hardness & toughness
- The links have rounded edges to prevent damage to the tyres

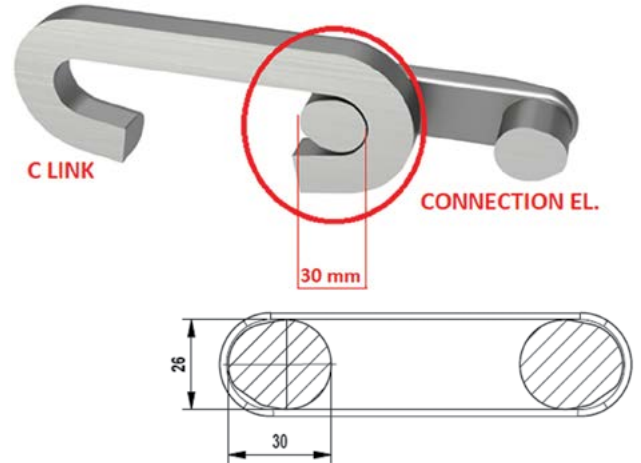

Short Joining Link VE.CMG-26X75



Medium Joining Link VE.CMG-26X120



Long Joining Link VE.CMG-26X165



Assembly Hook/Staple  
KLJ-MON-G



Tensioner for Single  
Wheel Tyre Tracks  
VE.OR-MON-G-SK



Tensioner for Bogie  
Wheel Tyre Tracks  
VE.OR-MON-G-UNI



Extension Kit



# TYRE TRACK PACKAGING

- Each SET of tracks (2x complete tracks) consists of at least four sections.
- Tracks are packaged with half a SET (1x complete track) per pallet
- A SET of tracks include 2x complete tracks, 8x short (75mm) and 8x long (160mm) joining links fitted with screws & nuts and 2x assembly hooks
- Track extension kits are required for Bogie tracks with 1900mm wheel centres. These are sold separately.
- Track tensioners are sold separately.

## BOGIE WHEEL TYRE TRACK SET

These are packaged as shown below on 2 pallets, 1200mm x 1600mm x 1100mm high

## SINGLE WHEEL TYRE TRACK SET

These are packaged as shown below on 2 pallets, 1200mm x 800mm x 1100mm high



# TYRE TRACK FITTING INSTRUCTIONS

Firstly, check you have the correct tracks for your tyres. Each track has a marking plate on it that shows the track type, tyre size & tyre type. Make sure this matches the markings on your tyres.

<b>MU 26</b>	TRACK TYPE & LINK SIZE
<b>710/45-26,5</b>	TYRE SIZE & TYPE
<b>12845-12</b>	SERIAL NUMBER

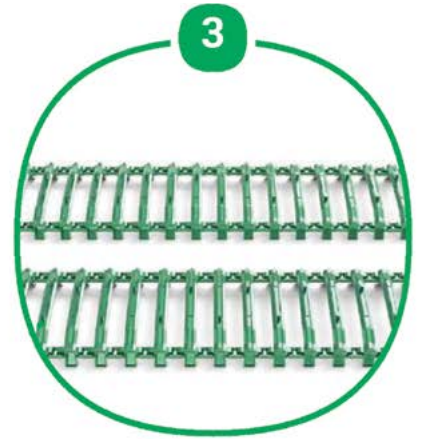
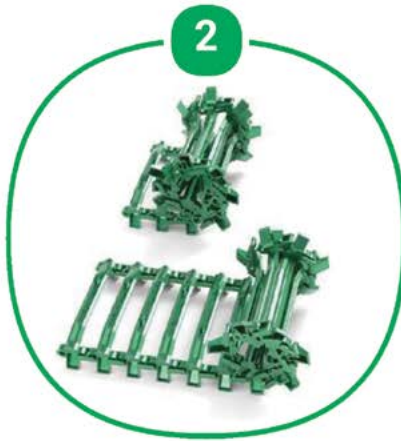

Unroll your tracks with the cleats facing up. Each track comes in 2 sections labeled as No.1 & No.2.

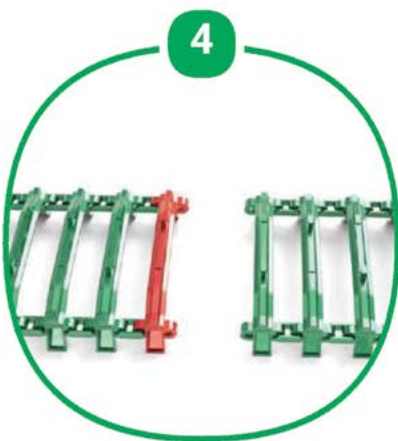

The track section No.1 has joining links at one end. Put the No.2 track at this end & connect as shown. (if the lug pattern is staggered left to right, check the orientation is correct)

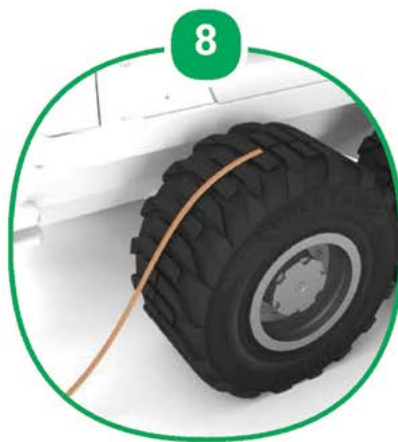
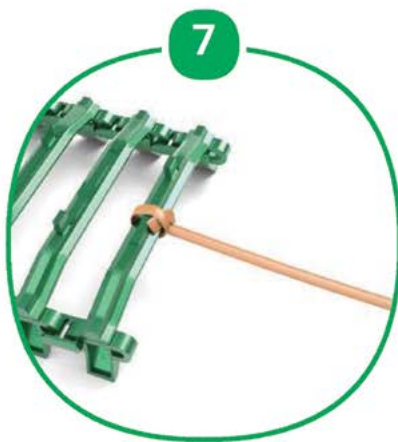

Tie a rope on one end of the tracks & run it up and over the tyres.

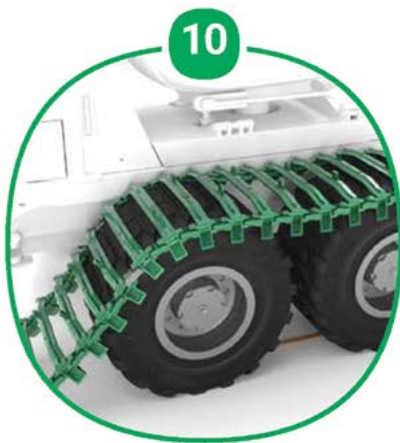

Slowly move the machine along to bring the tracks up, over & under the tyres until the ends of the tracks meet. Insert an assembly hook on each side to hold the tracks together.



Move the machine along until the assembly hooks reach the middle of the bogie tyres. Use the tensioner tool to pull the tracks together, remove the hooks & fit the joining links as shown.

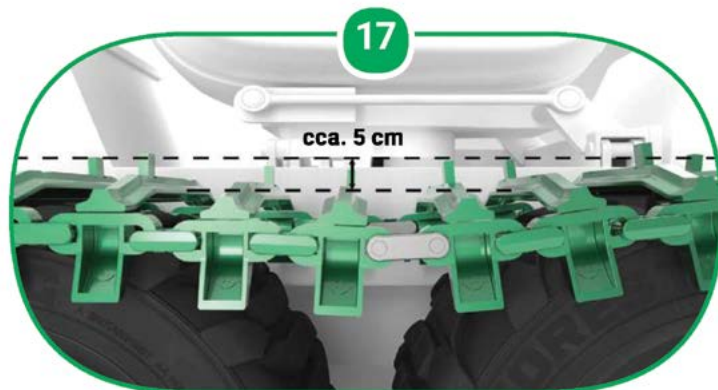

Check the tyre pressures are correct & use the right length joining links to give a track sag of 50mm as shown for Bogie tracks. Your track installation is now complete. Remember to check the track sag after a few days of work & ensure the tyres remain at the right pressures.

## MACHINE CLEARANCE

In order to avoid tracks hitting or fouling the machine bunk or bodywork (which can in extreme cases cause transmission problems), a minimum clearance gap of 50mm between track and machine should exist. The tracks should be properly tensioned at all times.

*This clearance gap should be measured with:*

- **The track pushed on the tyres towards the machine**
- **The bogey at maximum tilt angle - the worst possible scenario**

Without this clearance there is a possibility of track/machine fouling when tracks wear, become slack or are run at faster than normal speeds

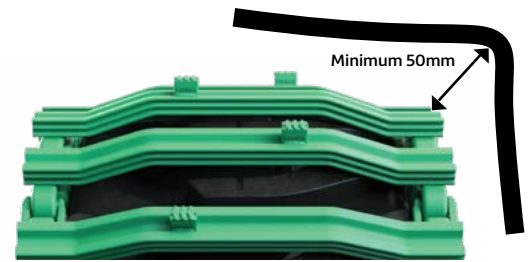

### PLEASE NOTE...

Many 8 wheel drive machines have less clearance at the front of the machine for tracks than at the back. When tracks are fitted to the front of the machine, ensure there is adequate clearance between tracks and machine bodywork such as:

- **Clearance from doors**
- **Air intakes**
- **Front blades**
- **Cab ladders**

This should be tested at all bogey tilt angles with tracks pushed towards the machine on the tyres. When tracks are fitted to the rear of the machine, clearance is required between the tracks and the bunk frame. When bunk frames are repositioned, e.g. for different timber lengths, this can change track to frame clearances and must also be checked. Some machines are fitted with hydraulic bogey lifting rams and may be unsuitable for use with tracks due to inadequate clearances. Checks must be made prior to fitting tracks.

## TRACK RE-TENSIONING

When tracks are new, they will quickly slacken off over the first few days of use and will require re-tensioning. Re-tensioning involves the replacement of long track links with short track links and then the removal of one full track plate in order to maintain correct tension.

This slackening of new tracks is not any form of material stretching, but simply a “bedding in” process due to the numerous components in the track link system. It can be expected that the track will require re-tensioning frequently during the first week of work, with this task becoming less frequent as the tracks bed in.

It can also be expected to have to remove one complete track plate within the first three or four weeks of work and perhaps a second track plate after three to six months of work. The amount of wear experienced by the track link system over its working life is dependent upon the abrasiveness of the terrain together with the load and tension experienced by the tracks.

Bogie Tracks should be run with 50mm of sag provided that:

- **The tyres are not slipping and spinning inside the track**
- **The track is not falling off the tyres**
- **The track is not hitting the bodywork or any part of the machine**
- **The track is not causing any damage to the tyres**

Tracks which are over-tensioned will stress axles and hub bearings as well as increase tyre and track wear.

# TYRE SUITABILITY & PRESSURES

## TYRE SUITABILITY

Almost every tyre can be fitted with tracks, some are more suitable than others.

- Tyres should be designed for use with tracks
- The ideal tyre has a smooth, less aggressive tread pattern, with slightly rounded shoulders
- The tyre should have steel reinforcement within the carcass and be of heavy ply rating
- The tyre must be fitted to the correct steel reinforced wheel rim for forestry use
- The tyre must be fitted with the correct recommended inner tube, where applicable
- Tracks can only be fitted to machines with fixed wheel centre bogies



Forest Rider



TRS LS-2



Twin 422



Twin 428



Forest King F



Forest King F2



T440



T480

## TYRE PRESSURE CHART (NOKIAN)

### CROSS PLY

Dimension	Ply Rating	kPa	PSI
750/55-26.5	20	550	80
780/55-26.5	20	550	80





Tracks increase machine stability, offer increased traction and flotation. However, in order to obtain maximum advantages from using tracks, the following points should be duly observed.

- **The correct track must be selected for each task, considering terrain, machine size, tyre type and size to which the tracks will be fitted, driver experience and working practices**
- **Bogie Tracks must be correctly fitted and tensioned to have 50mm of sag at all times**
- **Tyres must be inflated to the correct pressure (usually the maximum permitted tyre pressure)**
- **Tracks should not hit or foul the machine bodywork at any time**

## DRIVING SPEEDS

The maximum driving speed with tracks should never exceed 12km/hr. This applies even on flat smooth surfaces or forest roads. Speeds should be considerably reduced in the forest and reduced further with a loaded forwarder and when operating on extreme terrain.

## TRACK INTERACTION WITH TYRE

Through in depth research and development, Veriga have designed tracks which achieve a fine balance for reduced track on tyre slippage while preventing severe tyre damage.

Every track cleat has been manufactured to have an underside grouser bar, used to grip the tyre surface. If this grouser bar is lubricated by driving in wet or clay conditions, or worn due to old age, slippage between track and tyre can occur.

Tyre slippage can also be a problem on very large, high horsepower machines which are heavily loaded and working on steep, wet ground. Where the bar is too sharp or aggressive, tyre damage may occur. As standard there is a 5-10mm gap between the paw and tyre (design range is between 2 and 20mm depending upon track design and tyre condition).



# TYRE TRACK MAINTENANCE



## TO PROLONG THE LIFE OF THE TRACKS & THEIR OPTIMAL USE, PROPER MAINTENANCE IS REQUIRED

- Check the tracks regularly for wear or damage & replace any assembly elements. This will help prevent unexpected breakages & downtime
- Check the track sag is always maintained at 50mm for Bogie tracks. This may involve using shorter joining links and/or removing cleats over time to tighten the track. Correct track tension will reduce the wear of the track & tyres and improve traction
- Check the tyre pressures regularly to ensure they are running at the correct levels
- If storing tyre tracks for long periods, keep them undercover or coat them in a penetrating lubricant to prevent corrosion







25 YEARS  
Tigercat

615E



***Delivering the solutions  
you need to stay  
productive***



**Phone us on**  
0800 654 323



**Email us at**  
[sales@west-trak.co.nz](mailto:sales@west-trak.co.nz)



**Visit our Website**  
[www.west-trak.co.nz](http://www.west-trak.co.nz)



**Head Office**  
32 Robertson Street  
Westport, 7825



**Auckland Branch**  
14 Hobill Ave, Wiri  
Auckland, 2104



Like us on **Facebook**



Follow us on **LinkedIn**

**Call 0800 654 323 to order your Tyre Tracks now!**



**West-Trak<sup>®</sup>**  
UNRIVALLED STRENGTH