



# CRUSHER WEAR PARTS

ARE YOU CRUSHING ROCK & RUBBLE? GET QUALITY WEAR PARTS  
THAT LAST LONGER & INCREASE YOUR PRODUCTION



**West-Trak**  
UNRIVALLED STRENGTH

# CRUSHER WEAR PARTS

---

**Are you crushing rock & rubble? Get quality wear parts that last longer & increase your production.**

*“Customised options to suit your needs”*

.....

■ CONE CRUSHER PARTS .....	4
■ JAW CRUSHER PARTS .....	5
■ IMPACT CRUSHER PARTS .....	6
■ HAMMER MILL PARTS .....	7
■ CUSTOM MADE CRUSHER PARTS .....	8

.....



## Are you crushing it?

You'll need the toughest wear parts & solid back-up support to maximise your crushing productivity & performance.

We offer a large range of quality Crusher parts for all makes & models of Cone Crushers, Jaw Crushers, Impact Crushers & Hammer Mills.

Our Crusher parts are high quality castings, guaranteed to perform in the most extreme wear & impact conditions.

- Customised options of Manganese & Chrome Iron material compositions to suit your needs
- Well proven in the hardest, most abrasive rock Quarries in the world
- Free on-site measure ups & technical advice
- Custom made parts from 500HB abrasion steel & Chromium Carbide overlay plate

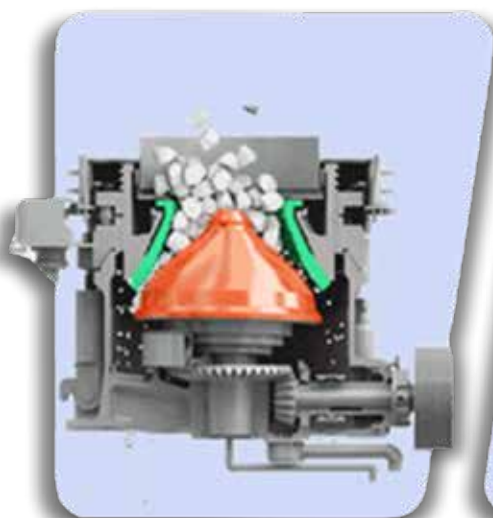

**CONE CRUSHER**



**JAW CRUSHER**

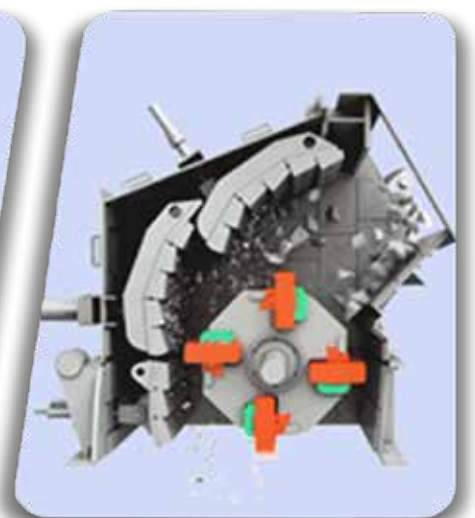

**IMPACT CRUSHER**



# **CONE CRUSHER PARTS**

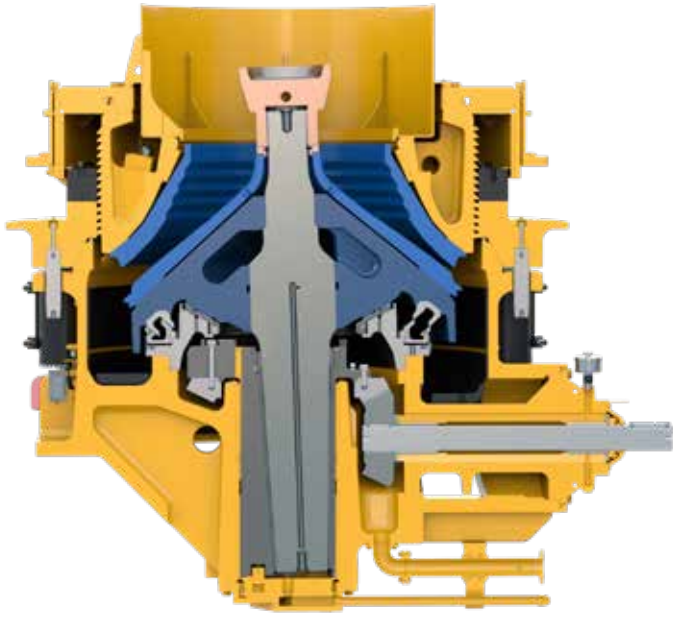

- We offer a wide range of quality Concave Bowl Liners, Mantles & supplemental parts for all brands of cone crushers
- Our parts are cast from the highest grade of ferro Manganese & Chromium to provide the hardest composition, for maximum wear resistance in the most extreme crushing conditions
- Custom designs & compositions can be made to best suit your crushing needs



# JAW CRUSHER PARTS



- A large range of quality Jaws, Toggle Plates & Cast Cheek plates are available for all brands of Jaw Crushers
- Our Jaws & Cheek plates are cast from the highest grade of ferro Manganese & Chromium, to provide the hardest composition for maximum wear resistance
- We offer a wide variety of tooth profiles & surface shapes to best suit your crushing needs. Custom designs & compositions can also be made to suit your needs

## Tooth Profiles





# IMPACT CRUSHER PARTS

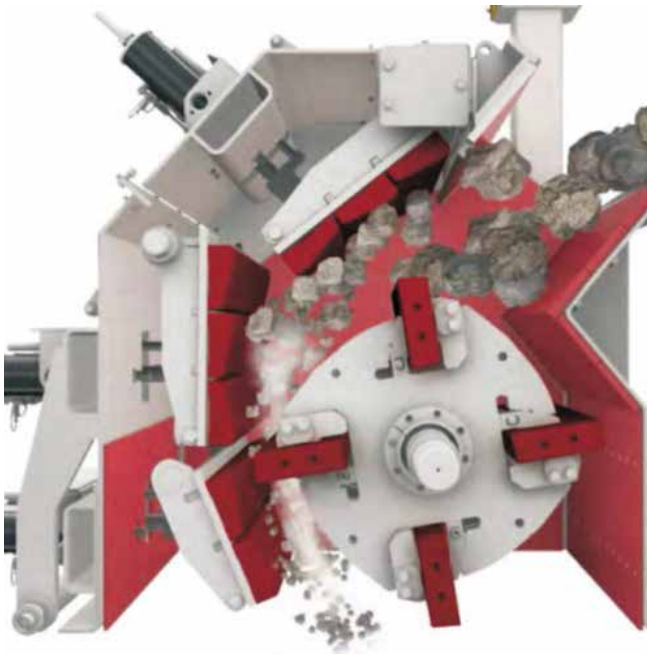

- We stock a large range of quality Blow Bars, Impact Plates & Side Liner Plates for all brands of horizontal shaft Impact crushers
- Our Blow Bars & Impact plates are cast from the highest grade of ferro Manganese & Chrome Iron. Options of integrated Chrome Ceramic & integrated Martensitic Ceramic compositions are also available
- Custom designs & compositions can be made to best suit your crushing needs

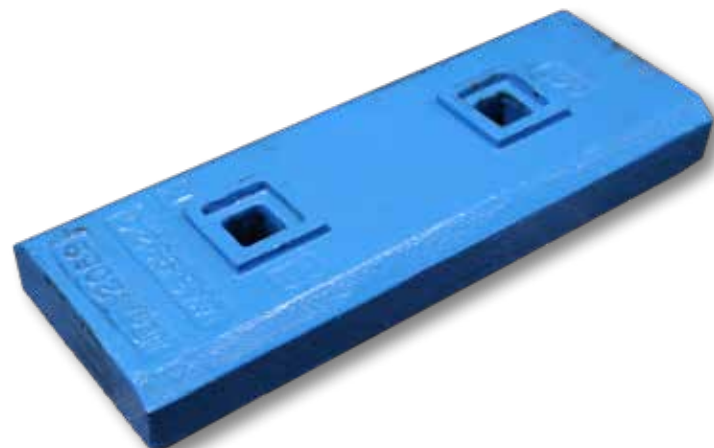

# HAMMER MILL PARTS

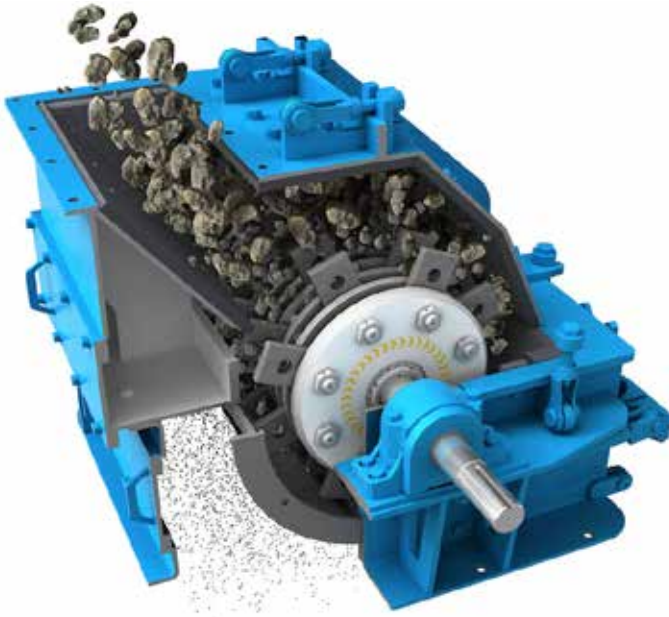

- We offer a large range of Hammers, custom made Side Liner Plates & Gridbars for all brands of Hammer Mills
- Our Hammers are cast from the highest grade of ferro metals, to provide the hardest compositions for maximum wear resistance in the most extreme crushing conditions
- Custom designs & compositions can be made to best suit your crushing needs

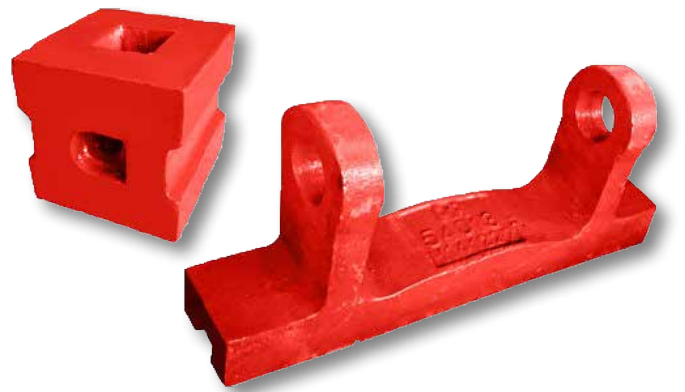



Liner plates with threaded studs



Wear plates with keyway holes



Machined Hammer Mill plates



Grizzly Screen Grid Bars



Rolled Chromium Carbide liners



Profile Cut Screen Plates







***Delivering the solutions  
you need to stay  
productive***



**Phone us**

0800 654 323



**Email us**

[sales@west-trak.co.nz](mailto:sales@west-trak.co.nz)



**Visit our Website**

[west-trak.co.nz](http://west-trak.co.nz)



**Head Office**

32 Robertson Street  
Westport, 7825



**Auckland Branch**

14 Hobill Ave, Wiri  
Auckland, 2104



**Cromwell Branch**

9a Rogers Street  
Cromwell, 9310



Like us on **Facebook**



Follow us on: **LinkedIn, Instagram  
TikTok, YouTube**



**West-Trak**  
UNRIVALLED STRENGTH