



CRUSHER WEAR PARTS

KEEP CRUSHING IT FOR LONGER WITH OUR LARGE RANGE OF WEAR PARTS FOR ALL TYPES OF CRUSHING MACHINES!

Call **0800 654 323** to order your parts **now!**



West-Trak[®]
UNRIVALLED STRENGTH

ARE YOU CRUSHING IT?



You'll need the toughest wear parts & solid back up support to maximise your crushing productivity & performance.

We offer a large range of quality Crusher parts for all makes & models of Cone Crushers, Jaw Crushers, Impact Crushers & Hammer Mills.

Our Crusher parts are high quality castings, guaranteed to perform in the most extreme wear & impact conditions.

- Customised options of Manganese & Chrome Iron material compositions to suit your needs
- Well proven in the hardest, most abrasive rock quarries in the world
- Free onsite measure ups & technical advice
- Custom made parts from 500HB abrasion steel & chromium carbide overlay plate

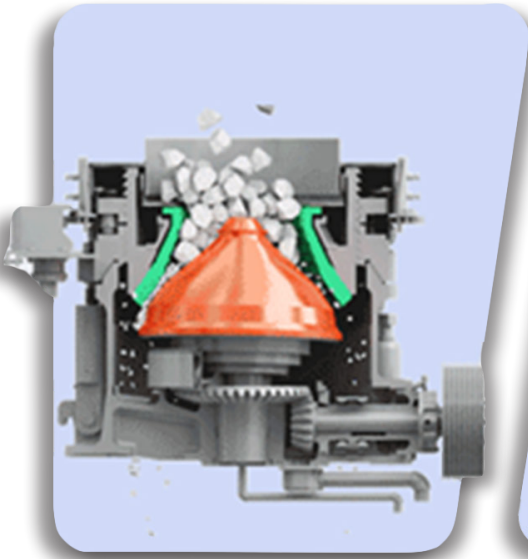

CONE CRUSHER



JAW CRUSHER

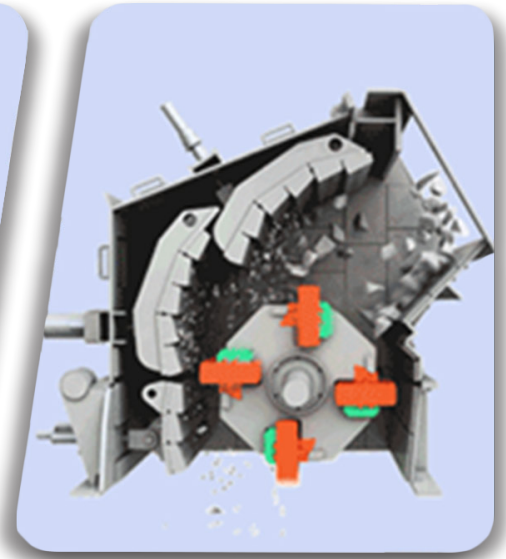

IMPACT CRUSHER



CONE CRUSHER PARTS



We offer a wide range of quality Concave Bowl Liners, Mantles & supplemental parts for all brands of cone crushers.

Our parts are cast from the highest grade of ferro Manganese & Chromium to provide the hardest composition, for maximum wear resistance in the most extreme crushing conditions.

Custom designs & compositions can be made to best suit your crushing needs.

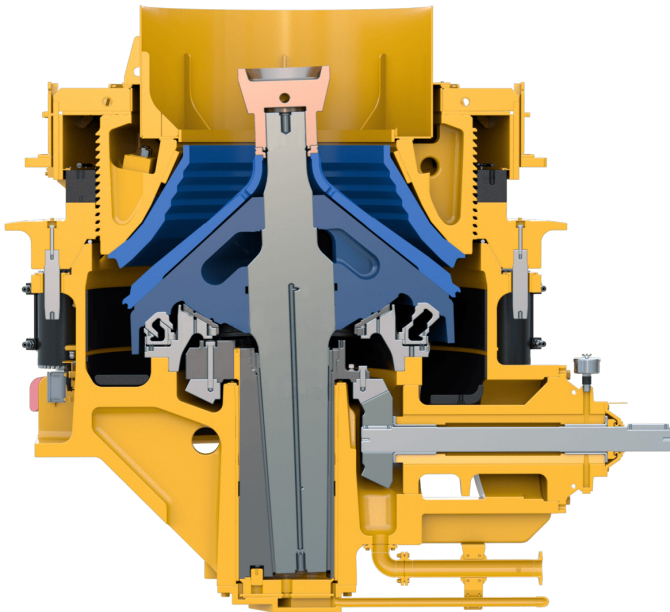

We'll help you crush it for longer!

Call 0800 654 323 for a FREE onsite visit by our crusher expert!



JAW CRUSHER PARTS

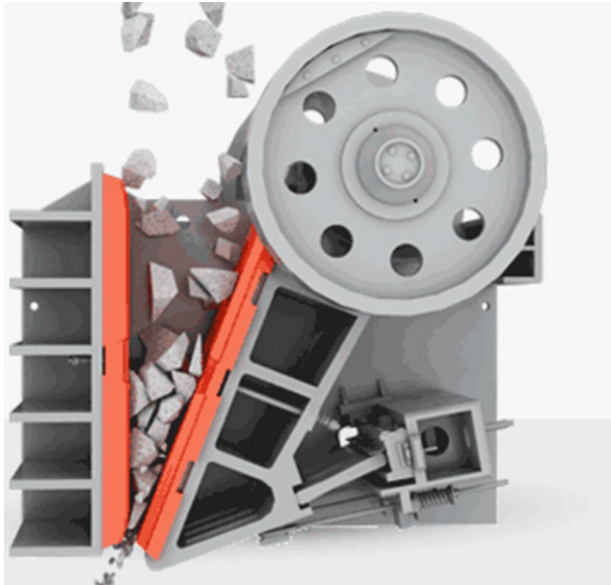

A large range of quality Jaws, Toggle plates & cast Cheek plates are available for all brands of Jaw crushers.

Our Jaws & Cheek plates are cast from the highest grade of ferro Manganese & Chromium, to provide the hardest composition for maximum wear resistance.

We offer a wide variety of tooth profiles & surface shapes to best suit your crushing needs. Custom designs & compositions can also be made to suit your needs.

Tooth Profiles

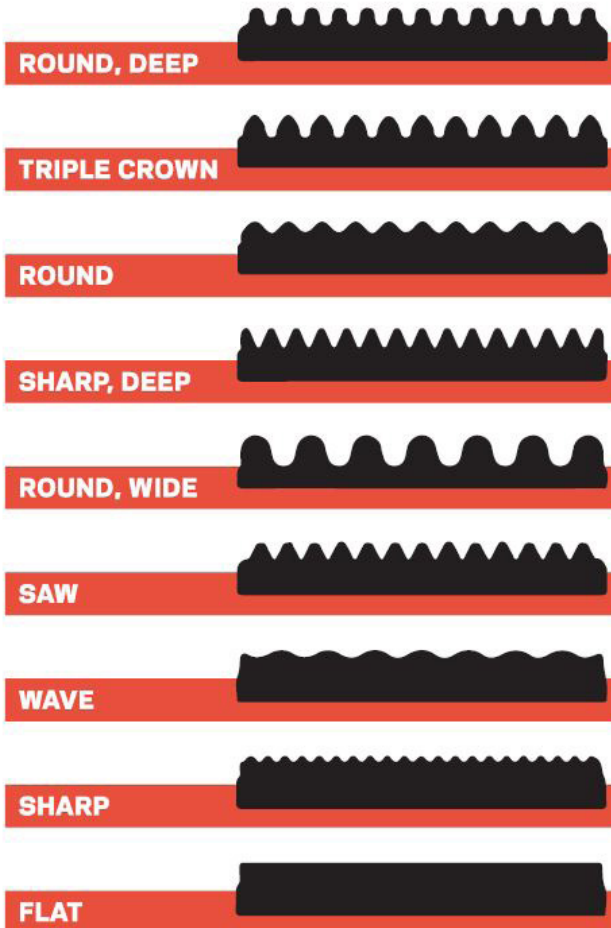

We'll help you crush it for longer!

Call 0800 654 323 for a FREE onsite visit by our crusher expert!



IMPACT CRUSHER PARTS

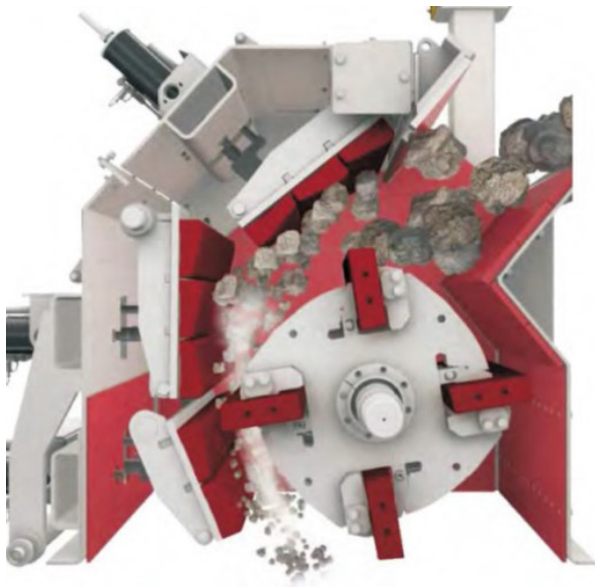
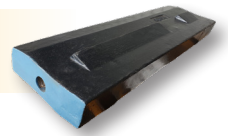

We stock a large range of quality Blow Bars, Impact Plates & Side Liner Plates for all brands of horizontal shaft Impact crushers.

Our Blow Bars & Impact plates are cast from the highest grade of ferro Manganese & Chrome Iron. Options of integrated Chrome Ceramic & integrated Martensitic Ceramic compositions are also available.

Custom designs & compositions can be made to best suit your crushing needs.

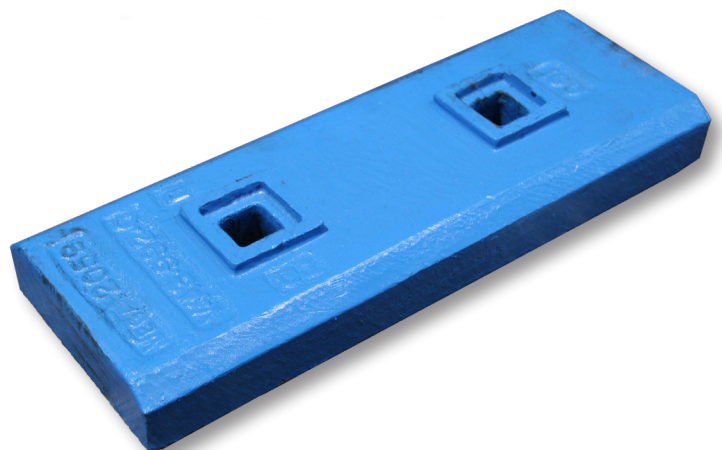
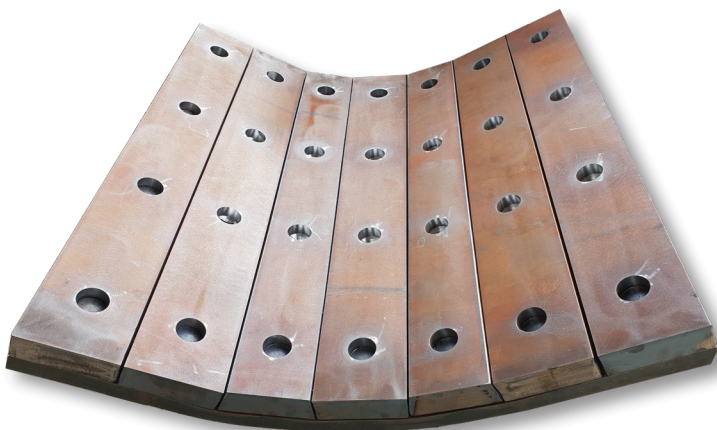

We'll help you crush it for longer!

Call 0800 654 323 for a FREE onsite visit by our crusher expert!



HAMMER MILL PARTS

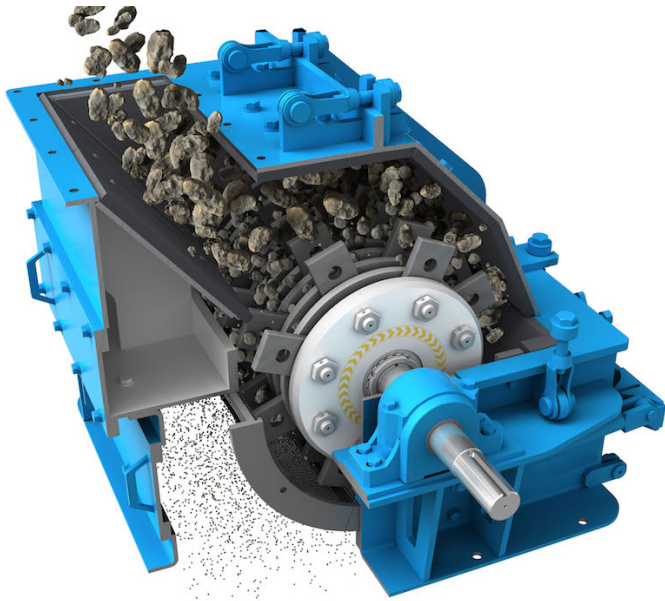

We offer a large range of Hammers, custom made Side Liner Plates & Gridbars for all brands of Hammer mills.

Our Hammers are cast from the highest grade of ferro metals, to provide the hardest compositions for maximum wear resistance in the most extreme crushing conditions.

Custom designs & compositions can be made to best suit your crushing needs.

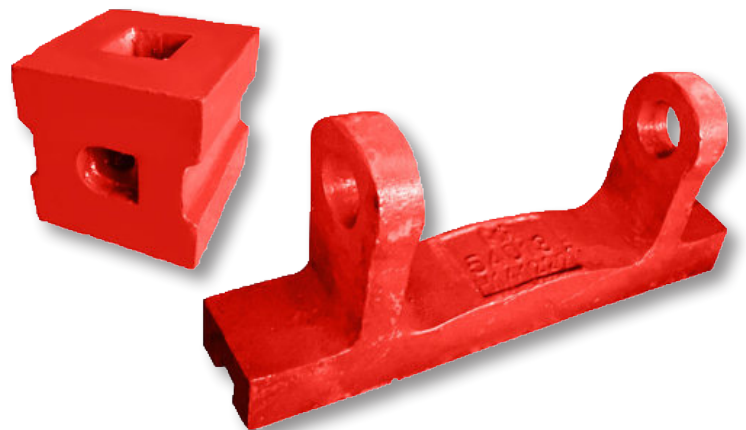
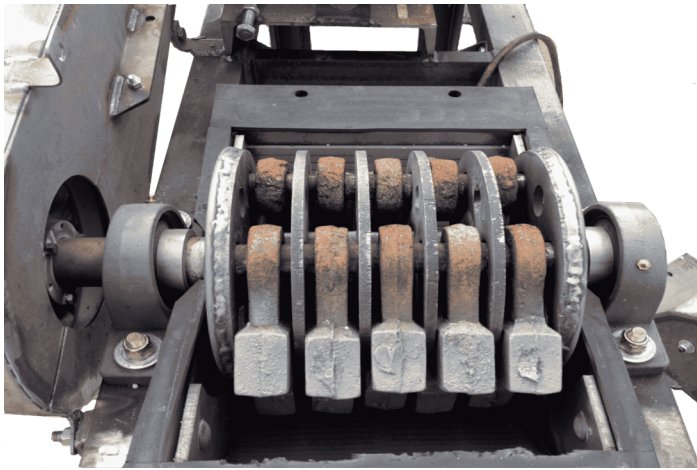

We'll help you crush it for longer!

Call 0800 654 323 for a FREE onsite visit by our crusher expert!



CUSTOM MADE CRUSHER PARTS

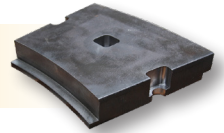

Liner plates with threaded studs



Wear plates with keyway holes



Machined Hammermill plates

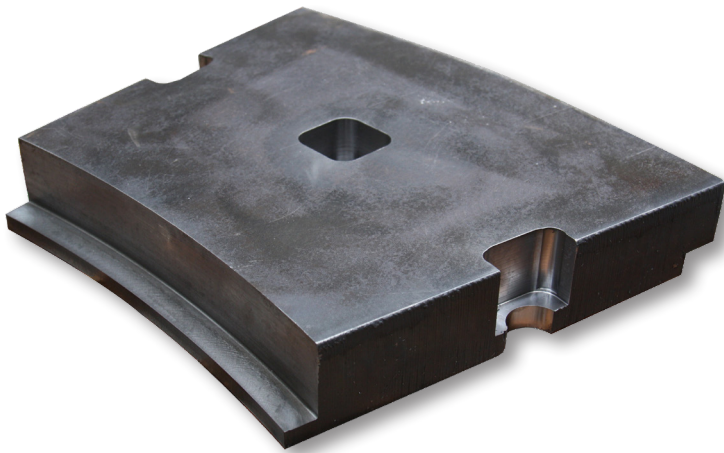

Grizzly Screen Grid Bars



Rolled Chromium Carbide liners



Profile Cut Screen Plates



We'll help you crush it for longer!

Call 0800 654 323 for a FREE onsite visit by our crusher expert!





***Delivering the solutions
you need to stay
productive***



Phone us on
0800 654 323



Email us at
sales@west-trak.co.nz



Visit our Website
www.west-trak.co.nz



Head Office
32 Robertson Street
Westport, 7825



Auckland Branch
14 Hobill Ave, Wiri
Auckland, 2104

Call 0800 654 323 to order your parts now!



West-Trak[®]
UNRIVALLED STRENGTH